



SIKA MARINE APPLICATION GUIDE

GENERAL MARINE ELASTIC BONDING APPLICATIONS

Version 2/2017

CONTENT

03 Bedding and Sealing Fittings and Hardware

05 Bonding of Rub Rails and Fenders

07 Bonding Decorative Panels and Work Surfaces

09 Bonding Lightweight Internal Partitions

11 Elastic Thick Layer Bonding



BEDDING AND SEALING FITTINGS AND HARDWARE

GENERAL DESCRIPTION

All kinds of deck fittings and hardware need to be securely fixed and totally watertight. Some of these fittings can be subject to very high forces, such as tensile, torsion and shear stresses. Poorly sealed joints can suffer serious damage such as metal corrosion, osmosis and water leaks which can cause damage to interior furnishings and fittings.

BEDDING AND SEALING OF FITTINGS SUBJECT TO HIGH MECHANICAL STRESSES

Deck fittings such as chain plates, winches and guide rollers must absorb very high dynamic stresses.

For this purpose a high-performance product, such as Sikaflex®-292i, should be used in conjunction with additional mechanical fixings.

BEDDING AND SEALING OF FITTINGS SUBJECT TO MINIMAL MECHANICAL STRESSES





Deck fittings, such as ventilators and cover strips, need to be waterproofed, but are not subject to high tensile or torsion stresses.

These fittings can be effectively bedded and sealed with only Sikaflex®-291i or if the joint remains visible and is exposed to weathering, the use of Sikaflex®-295 UV is recommended.



BEDDING AND SEALING FITTINGS AND HARDWARE

SUBSTRATE PREPARATION





TIMBER DECKS

	Abrade the contact area on the deck with a sanding pad (80 / 100 grit)
	Remove the dust with a vacuum cleaner
	Apply a thin, continuous coat of Sika® MultiPrimer Marine using a clean brush or a roller felt applicator.
	Drying times: Sika® MultiPrimer Marine 30 minutes (min) to 24 hours (max)

PAINTED DECKS





	Pre-treat the substrate with Sika® Aktivator-100, using a clean, lint-free rag or a paper towel. Change the rag frequently!
	Flash-off: 10 minutes (min) to 2 hours (max)

BRONZE, BRASS OR STAINLESS STEEL FITTINGS





	Slightly abrade the contact area with a very fine sanding paper or abrasive pad
	Pre-treat the substrate with Sika® Aktivator-100, using a clean, lint-free rag or a paper towel. Change the rag frequently!
	Flash-off: 10 minutes (min) to 2 hours (max)
	Apply a thin, continuous coat of Sika® MultiPrimer Marine, using a clean brush or a felt applicator
	Drying time: 30 minutes (min) to 24 hours (max)

For coloured metals please use only Sikaflex®-295 UV or Sikaflex®-591.

ALUMINUM FITTINGS

	Lightly abrade the contact area with a very fine sanding paper
	Pre-treat the substrate with Sika® Aktivator-100, using a clean, lint-free rag or a paper towel. Change the rag frequently!
	Flash-off: 10 minutes (min) to 2 hours (max)
	Apply a thin, continuous coat of Sika® MultiPrimer Marine, using a clean brush or a felt applicator
	Drying time: 30 minutes (min) to 24 hours (max)

APPLICATION OF Sikaflex®-291i, -292i OR -295 UV ADHESIVES

	Mask the surrounding area before priming and sealing
	These adhesives should be applied to the deck and to the screw fixing holes in a bead of the required thickness. The fitting should then be pressed into position
	The fixing screws should be tightened slightly to leave about 1 mm of adhesive under the fitting
	Use a plastic spatula to remove excess sealant squeezed out around the edges and remove the masking tape
	After 24 hours tighten the screws

IMPORTANT:
For the preparation of other substrates, please refer to the Sika Pre-Treatment Charts for Marine Applications.



Fig. 1 A selection of cleats that can be sealed or bonded using Sika adhesives



Fig. 2 Applying Sikaflex®-292i



Fig. 3 A port-hatch, both bonded and sealed using Sikaflex®



BONDING OF RUB RAILS AND FENDERS

GENERAL DESCRIPTION

Rub rails and fenders are designed to protect the hull of a vessel against damage. These act as a bumper to absorb impacts and scrapes, and the more elastic these are, the more effectively they perform this function.

The elastic behaviour varies according to the type of material used, so the shock-absorbing performance of the rub rail can be significantly improved by the use of an elastic adhesive joint. This provides maximum protection to the hull.

Rub rails of timber, PVC or polyurethane can be securely bonded to marine hulls using Sikaflex®-292i. The resulting elastic joint helps to absorb most of the shear and tensile stresses to which they are subjected when a vessel is docking or casting off.

If rub rails are secured with screws, a similar effect can be obtained by back-filling the rail profile with Sikaflex®-291i; a highly elastic polyurethane sealant. As well as absorbing torsional stresses, this technology also seals the screw holes and prevents water or dirt from getting behind the rub rail.









IMPORTANT:

If the rub rail has a different chemical composition and is not fixed using a mechanical fixing method, please seek advice from your local Sika company.

BONDING RUB RAILS TO THE HULL

SUBSTRATE PREPARATION

GRP HULLS

 208	Heavily soiled surfaces should first be cleaned off with a pure solvent, like Sika® Remover-208, to remove the worst of the soiling
	Lightly abrade the contact area with a very fine sanding pad
	Remove the dust with a vacuum cleaner
 SA 100	Pre-treat the substrate with Sika® Aktivator-100, using a clean, lint-free rag or a paper towel. Change the rag frequently!
	Flash-off: 10 minutes (min) to 2 hours (max)
 SMM	Apply a thin, continuous coat of Sika® MultiPrimer Marine, using a clean brush or a felt applicator
	Drying time: 30 minutes (min) to 24 hours (max)

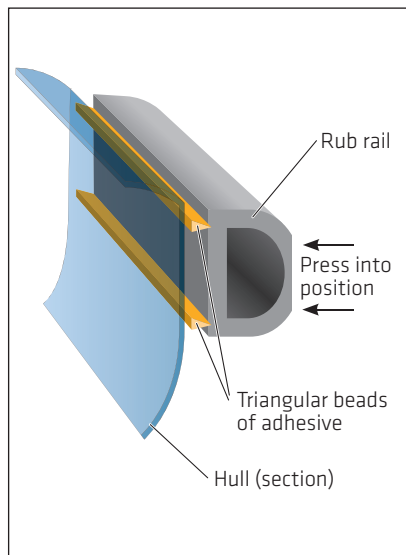







Fig. 4 Assembly of a rub rail







FINISHED PAINTED HULLS OF ALUMINUM OR STEEL, COATED WITH A TWO-PART LACQUER

 SA 100	Pre-treat the substrate with Sika® Aktivator-100, using a clean, lint-free rag or a paper towel. Change the rag frequently!
	Flash-off: 10 minutes (min) to 2 hours (max)









TIMBER RUB RAILS

	Abrade the contact area of the hull with a sanding pad (80 / 100 grit)
	Remove the dust with a vacuum cleaner
 SMM	Apply a thin, continuous coat of Sika® MultiPrimer Marine using a clean brush or a felt applicator.
	Drying times: Sika® MultiPrimer Marine 30 minutes (min) to 24 hours (max)

MOULDED PVC OR POLYURETHANE RUB RAILS

	The bond face of the rub rails must be free from mould release agents or other chemical contaminants. All traces of such substances must be removed before proceeding with Sika® Remover-208
	Abrade the bond face of the rub rail with coarse sand paper (60 / 80 grit) to key the surface
 SA 205	Pre-treat the substrate with Sika® Aktivator-205 using a lint-free rag or paper towel. Change rag frequently.
	Flash-off min. 10 min to max 2h.
 SMM	Apply a thin continuous coat of Sika® MultiPrimer Marine using a clean brush or felt applicator
	Drying time: 30 minutes (min) to 24 hours (max)

APPLICATION OF Sikaflex®-292i OR Sikaflex®-291i

	Apply a masking tape on the substrate
 292i 291i	Apply Sikaflex®-292i (or Sikaflex®-291i if rub rails are to be held using additional mechanical fixings) to the bond area using an appropriate triangular bead (Fig.1)
	Assemble the components within 20 minutes of applying the adhesive
	Press the rub rail into place, either directly onto the face of the hull
	Use clamps, etc., to hold the rub rail in position while the adhesive sets. If the rub rail is to be secured with mechanical fixings, any holes should also be filled with adhesive
	Remove excessive adhesive and the masking tape
 208	Uncured Sika adhesives or sealants can be removed with Sika® Remover-208
	Clamps and other fastening aids can be removed after 24 hours. Full service strength is attained after approximately 7 days

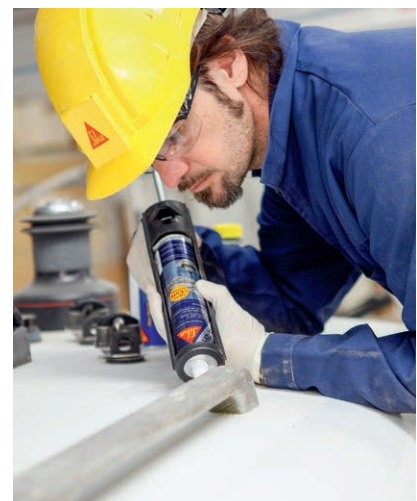

Fig. 5 Sealing the edge of a chrome hand-rail



BONDING DECORATIVE PANELS AND WORK SURFACES

GENERAL DESCRIPTION



The interiors of many boats are based on a variety of traditional and modern materials including mirrored glass. These panels can be used functionally as working surfaces (galley worktops, etc.) or cosmetically. Either way, elastic bonding provides an easy, durable method of fixing without visible and unsightly mechanical fixings.

As the variety of materials used for panels, surfaces and supporting substrates is so vast, please consult the local Technical Service of Sika Industry or proceed to preliminary trials.









BONDING DECORATIVE PANELS AND TABLES

SURFACE PREPARATION

	Lightly abrade the bonding area with a very fine abrasive pad
 SMM	Apply a thin continuous coat of Sika® MultiPrimer Marine using a clean brush or felt applicator
	Sika® MultiPrimer Marine 30 minutes (min) to 24 hours (max)

APPLICATION OF Sikaflex® ADHESIVE TO VERTICAL PANELS

	Prepare the substrate according to the Pre-Treatment Chart for Marine Application
	Place spacers in position (thickness 2 mm, approximately 50 Shore A hardness). These can be pressed into the adhesive once applied
	Apply appropriate beads of Sikaflex®-292i in an 8 mm x 10 mm triangular profile
	Assemble the components within 20 minutes of applying the adhesive
	Apply pressure with fastening aids to compress the adhesive to the height of the spacers
	Wait at least 24 hours before walking on the bonded plates
 208	Uncured Sika adhesives or sealants can be removed with Sika® Remover-208

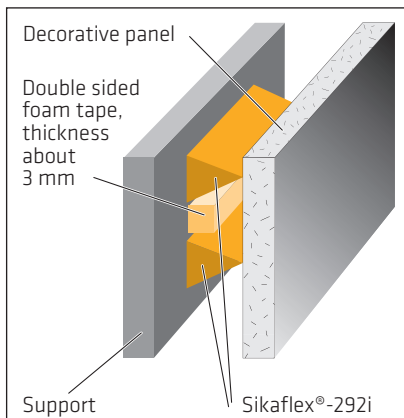









Fig. 6 Bonding a decorative panel vertically

APPLICATION OF Sikaflex® ADHESIVE TO HORIZONTAL PANELS

 298	Horizontal surfaces: Sikaflex®-298. Inclined surfaces: Sikaflex®-291i
	Slightly abrade the surface with a abrasive pad very fine
 SA 205	Pre-treat the surface with Sika® Aktivator-205 with a lint-free rag or paper towel. Change the rag frequently!
	Flash-off time min. 10 min to max. 2 h
	Apply adhesive to the previously prepared surface and spread over the area to be covered, using a spreader with 4 mm triangular notches. The bed thickness may vary depending on the thickness of any gaps that needs to be filled (normally 1-2 mm)
	If vapour-tight substrates are used, spray a fine mist of water (1 g / m ²) onto the Sikaflex®-298 surface for faster curing
	The deck panel must be positioned accurately within the tack free time of the adhesive and pressed firmly into place to avoid air-entrapment
	Clamps, weights or screws (removable once the adhesive has set) can be used to secure the panel while the adhesive sets. After about 24 hours the panels can carry their full service load and the temporary fastenings can be removed

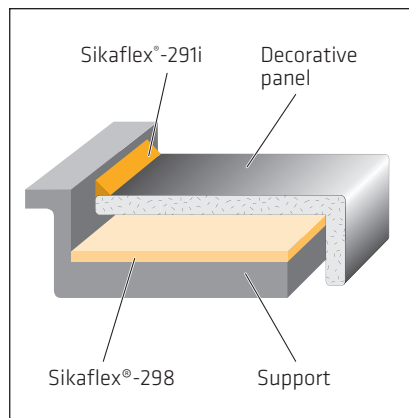

Fig. 7 Bonding a decorative panel vertically



Fig. 8 A galley work surface fitted using Sikaflex®-292i



IMPORTANT:
Always refer to the current Sika Product Datasheets and Safety Datasheets obtainable through your local Sika company



Fig. 9 Application of Sikaflex®-291i



BONDING LIGHTWEIGHT INTERNAL PARTITIONS

GENERAL DESCRIPTION

These lightweight panels are usually constructed of wood sandwiches with internal polyurethane foam or honeycomb core. They are particularly suited as partitions for cabins and technical rooms as they are of lighter weight than wood filled panels and have good soundproofing properties.

Due to the low density core, lightweight panels cannot be mechanically fixed to the hull structures in the same way as traditional plywood panels.

However, bonding with Sikaflex®-292i is an ideal replacement fixing method that also possesses the flexibility to respond to the movements and stresses of the assembly.

The uniform stress distribution prevents damages which may be result of stress concentration (example screw).

This process is also endorsed by the manufacturers of the lightweight panels.

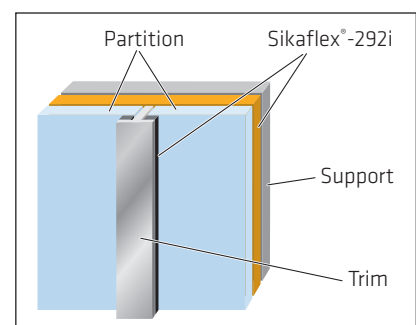

Fig. 10 Sikaflex®-292i bead application for bonding to the support

BONDING LIGHTWEIGHT INTERNAL PARTITIONS

SUBSTRATE PREPARATION

Please refer to the Sika Pre-Treatment Chart for Marine Applications.

APPLICATION OF Sikaflex®-292i ADHESIVE



Dry fit the panels to ensure an accurate fit and correct dimensioning. Prepare the surface accordingly



Place the spacers in position (thickness typically 3 mm, approximately 50 Shore A hardness)



Apply Sikaflex®-292i to the appropriate bond face using an appropriate bead



Assemble the components within 20 minutes of applying the adhesive



208

Uncured Sika adhesives or sealants may be removed with Sika® Remover-208



Panels can be held in place during cure by clamps or support brackets



Clamps and other fastening aids can be removed after 24 hours



Fig. 12 Lightweight panels being fitted to an open hull



Fig. 11 Sikaflex®-292i applied to a lightweight panel prior to fitting



Fig. 13 High-quality lightweight panels finished in traditional high-gloss wood veneer and bonded using Sikaflex®-292i



ELASTIC THICK LAYER BONDING

INTRODUCTION

From the earliest of times, boat construction has relied upon the available technology. Structural members needed to be attached to one another and everything would depend on the reliability of the bond.

Trial and error would have exposed the weaknesses in design and construction and one of the costs would have been the loss of the vessel, if not of lives.

As knowledge and experience was shared, so technology improved and in a symbiotic advancement, boat building and other industries benefited.

Today, significant advances in adhesive technology have spurred a revolution in assembly techniques across all of industry. But none reap the benefits more than the marine industry.

APPLICATION DESCRIPTION

Elastic thick layer bonding in respect of this manual refers to the method of joining the main structural components or components that contribute to the strength and stability of the structure of the vessel.

Elastic thick layer bonding is responsible for a completely different approach to vessel design. Whereas earlier techniques worked from a rigid skeleton that had to be strong enough to support the deck, hull, superstructure, windows, and fittings, the new approach uses all of these major components as the primary structural members and uses the old skeletal parts in a lighter form to provide stiffening to the structure.

Each time that a screw was used to hold a major component to the skeleton, it introduced weaknesses in every part it

passed through and became a focal point for stresses.

Marine architects had to take this into consideration during the design phase and ensure that there were sufficient fixings placed evenly along the joint lines in order to distribute the stresses. The location, size and type of every screw had to be specified, drawn onto the plans, bought in and stored.

The laminating method (taping) provides a far better alternative to this approach in most applications, with fewer components, a simplified design and better stress distribution. But this method is highly labour intensive and comes with numerous health and safety issues.

Elastic thick layer bonding from Sika is relatively simple to design, tolerant of dissimilar materials, very strong and durable, and besides having few health and safety requirements, takes a fraction of the time of other techniques to assemble.

In service, the inherent flexibility of the Sika structural adhesives evenly distributes the stresses and the lightweight construction techniques result in a major weight saving and corresponding buoyancy and performance increase in the vessel.

For every structural application, national and international rules, regulations and approvals must be observed.

DISCLAIMER

The information, and, in particular, the recommendations relating to the application and end-use of Sika products, are given in good faith based on Sika's current knowledge and experience of the products when properly stored, handled and applied under normal conditions. In practice, the differences in materials, substrates and actual site conditions are such that no warranty in respect of merchantability or of fitness for a particular purpose, nor any liability arising out of

any legal relationship whatsoever, can be inferred either from this information, or from any written recommendations, or from any other advice offered.

The proprietary rights of third parties must be observed. All orders are accepted subject to our current terms of sale and delivery. Users should always refer to the most recent issue of the Sika Product Datasheet for the product concerned, copies of which will be supplied on request.



GLOBAL BUT LOCAL PARTNERSHIP

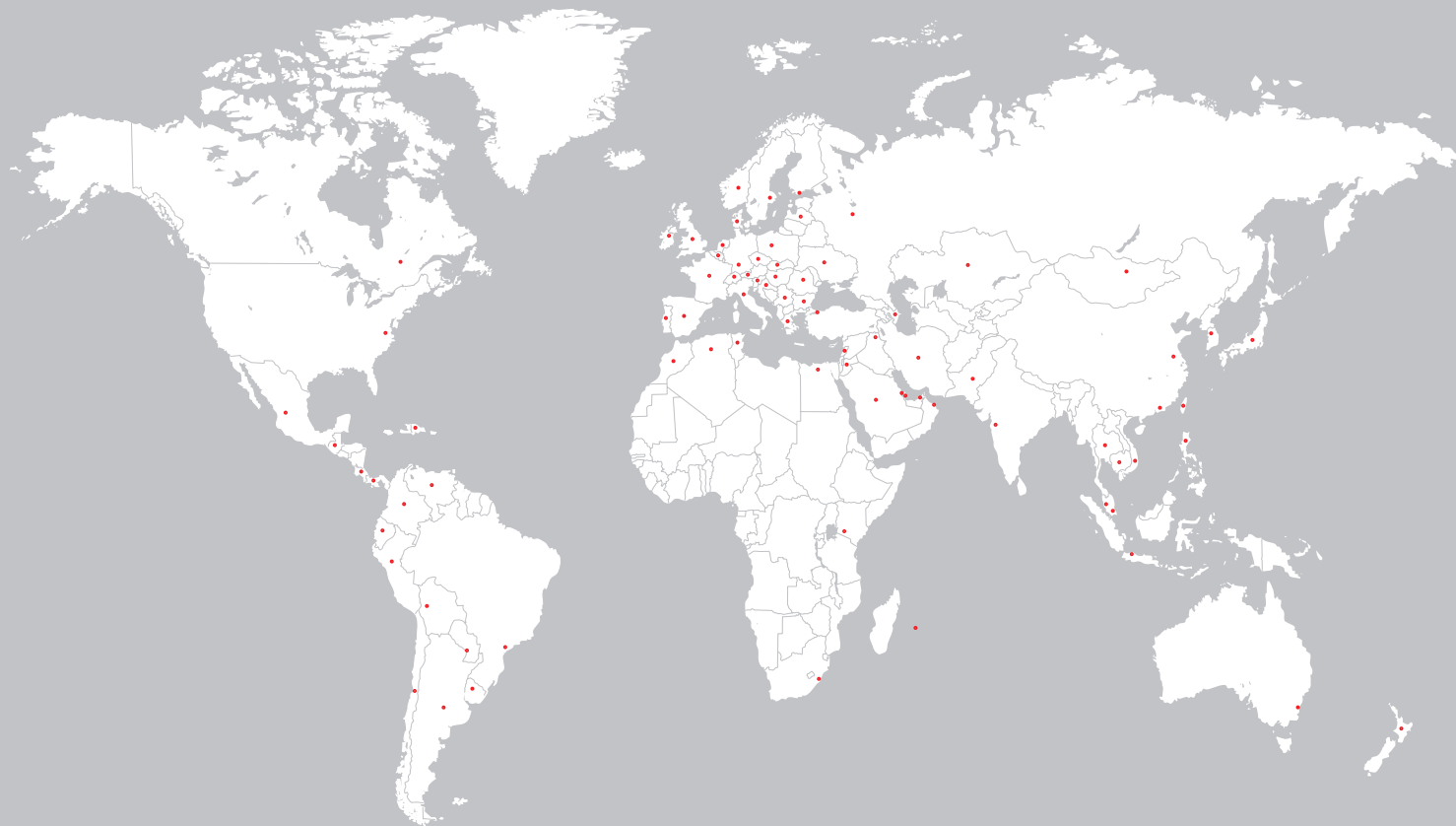

FOR MORE MARINE INFORMATION:



www.sika.com/marine

Who we are

Sika is a specialty chemicals company with a leading position in the development and production of systems and products for bonding, sealing, damping, reinforcing and protecting in the building sector and the motor vehicle industry. Sika has subsidiaries in 94 countries around the world and manufactures in over 170 factories. Its more than 17,000 employees generated annual sales of CHF 5.49 billion in 2015.

Our most current General Sales Conditions shall apply.
Please consult the Data Sheet prior to any use and processing.



Sika Services AG
Tueffenwies 16
8048 Zurich
Switzerland

Contact:
Phone: +41 58 436 40 40
Fax: +41 58 436 45 30
www.sika.com/marine

BUILDING TRUST

