

Construction

IXth

22/25
september eylül,

2004

uluslararası
INTERNATIONAL

**CORROSION
SYMPOSIUM
SEMPOZYUMU
KOROZYON**

AND EXHIBITION
TEKLERGÖZÜ

ANKARA, TURKEY

KOROZYON VE BETON
KORUMASI VE
KONKRET
KORUMAYA İLİŞLİ
TEKNOLOJİLERİN
GÜNCEL
DEĞERLENDİRİLMESİ
VE
GELECEĞİNE YÖNELİK
KONFERANS
HEDEFLERİ

ICCP

INTERNATIONAL CONCRETE
AND CORROSION PROTECTION
ASSOCIATION



www.iccp-tr.com

The corrosion management of reinforced concrete structures using corrosion inhibitors

Mark Shaw, Sika Ltd, UK

Abstract

This paper reviews the use of surface applied corrosion inhibitors as a technique for the remediation of reinforcement corrosion. The development, use and monitoring of materials are considered together with monitored case studies showing the effectiveness of the technique.

CONTENTS

1.	The corrosion of steel in concrete	3
2.	Repair and remediation options	4
3.	What is a corrosion inhibitor?	6
4.	The development of corrosion inhibitors	6
5.	Corrosion inhibitors for reinforced concrete	7
6.	A new class of surface applied corrosion inhibitor – Sika® FerroGard® (MAACI)	8
7.	How does Sika® FerroGard® work?	9
8.	Where can Sika® FerroGard® be used?	10
9.	System application	10
10.	Concrete suitability	11
11.	Corrosion monitoring	12
12.	Performance testing	14
13.	How long will Sika® FerroGard®-903 extend the life of a structure?	15
14.	The benefits of Sika® FerroGard®	16
15.	Case studies	17
16.	Conclusions	22
17.	References	22

Keywords

Anode, BRE digest, cathode, corrosion inhibitors, modified amino alcohol corrosion inhibitors, multifunctional inhibitor, remediation of reinforcement corrosion, Sika FerroGard inhibitor technology, corrosion monitoring, linear polarisation, concrete suitability. Proof performance tests, current densities, incipient anode effect, carbonation, chlorides.

Introduction

Owners, Architects and Consultants are striving to find more cost effective long term solutions to effectively control reinforcement corrosion in concrete through active corrosion management strategies. The use of corrosion inhibitors provides an alternative solution to this problem. The use of corrosion inhibitors have been successfully used for many years in other industries and is now becoming fully established in the construction industry as part of a full concrete repair and protection strategy.

1. The corrosion of steel in concrete

When steel is embedded in concrete, it is protected from corrosion by the passivating iron oxide layer on the steel and the alkaline environment (pH 12.5 - 13.5) of the concrete (Figure 1) despite high moisture levels which may exist in the concrete.

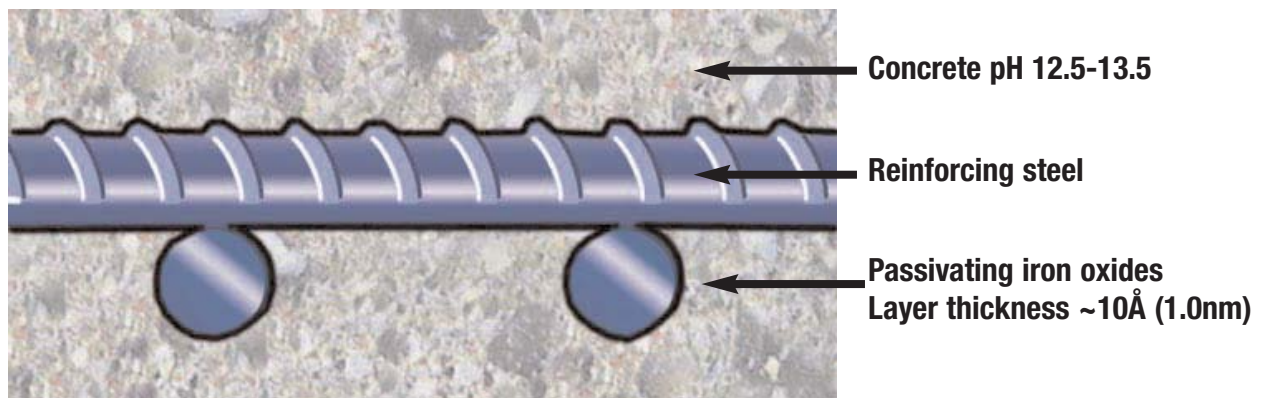

Figure 1: Alkaline environment protects reinforcing steel from corrosion For the corrosion of steel to occur in the concrete, certain conditions must prevail.

- A breakdown of the passivating layers such as carbonation of the cement matrix or the effect of chlorides on the steel.
- An electrolyte in the form of pore water within the concrete matrix.
- Oxygen which is always present in the concrete pores and which can permeate via capillaries and cracks.

The complex electrochemical mechanisms of corrosion induced by carbonation and chlorides has been well documented in many publications. The end result is the formation of various rust products, which gradually increase in volume causing expansive pressure on the concrete. This results in the propagation of cracks which leads to delamination spalling and the general degradation of the concrete which can affect the structural integrity and visual appearance of the structure (Figure 2).



Figure 2: Formation of rust causing spalling of concrete

2. Repair and remediation options

Once corrosion has been initiated and depending on the cause and severity of the corrosion process different repair and remediation strategies can be considered. Table 1, which is an extract from BRE Digest 444 Part 3 “Protection and remediation of reinforcement corrosion” and also referred to in the ICE document “Recommendations for the inspection, maintenance and management of car park structure,” (Figure 3) summarises the repair and remediation principles considered in Europe.



Figure 3

Table 1 Principles and methods for remediation of reinforcement corrosion as given in DD ENV 1504-9 (see Figure 2)		
Principle	Principle definition	Methods based on principle. (Italic text indicates the existence of supporting evidence that the method achieves protection by the appropriate principle)
Preserving or restoring passivity (RP) Principle 7	Creating conditions in which the surface of the steel reinforcement can maintain or return to a passive condition	7.1: Increasing cover to reinforcement with additional cementitious mortar or concrete 7.2: Replacing chloride-contaminated or carbonated concrete 7.3: Electrochemical realkalisation of carbonated concrete* 7.4: Realkalisation of carbonated concrete by diffusion 7.5: Electrochemical chloride extraction*
Increasing resistivity (IR) Principle 8	Increasing the electrolytic resistivity of the concrete	8.1: Limiting moisture content of the concrete by surface treatments, coatings or sheltering
Cathodic control (CC) Principle 9	Creating conditions in which potentially cathodic areas of reinforcement are unable to drive an anodic reaction	9.1: Limiting oxygen content by saturation of the concrete or surface coating† 9.2: Applying cathodic inhibitors to the concrete*†
Cathodic protection (CP) or prevention Principle 10	Polarising the steel reinforcement cathodically so as to reduce the rate of anodic reaction	10.1: Impressed current systems* 10.2: Sacrificial anode systems*
Control of anodic area (CA) Principle 11	Creating conditions in which potentially anodic areas of reinforcement are unable to take part in the corrosion reaction	11.1: Painting reinforcement with coatings containing active pigments 11.2: Painting reinforcement with barrier coatings† 11.3: Applying anodic inhibitors to the concrete*†

Annual budgeting restrictions tend to relegate most of our structures to a program of patch repairs to visibly damaged sites as a temporary measure before future maintenance and/or protection when the situation becomes more critical and therefore more costly.

A reactive approach to maintenance is shown in the corrosion model - Figure 4. A proactive approach is shown in Figure 5.

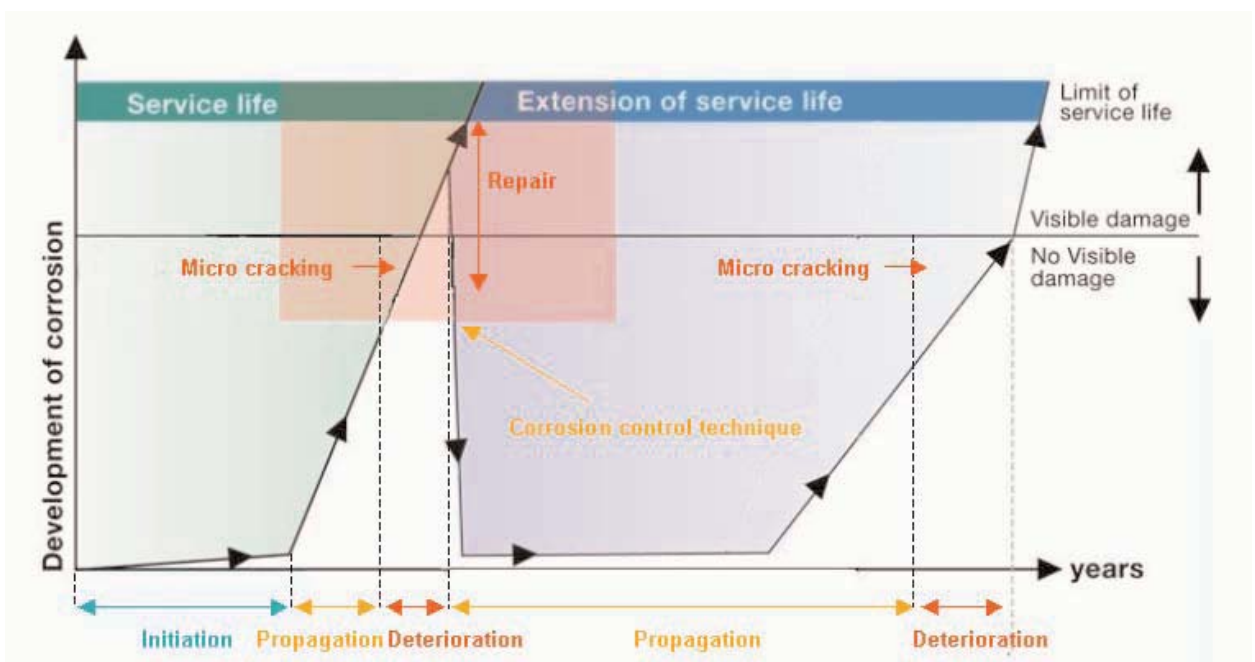

Figure 4: Reactive corrosion model

5. Corrosion inhibitors for reinforced concrete

The use of inhibitors to control corrosion of steel reinforcement in concrete is a relatively recent development. They are primarily used to satisfy one or more of the following concrete repair objectives:

- Reduce corrosion rates in carbonated or chloride contaminated concrete
- Reduce the incipient anode effect
- Delay the onset of corrosion in carbonated or chloride contaminated concrete (preventative treatment)

Early investigative work was carried out in the late 1960's and early 1970's. Inhibitors fall into several categories. The three principal classes are:

5.1 Anodic Inhibitors

This class of inhibitor is designed to suppress the anodic reaction by the formation of a protective film on the anode. Anodic inhibitors can be considered dangerous if the concentrations are not high enough. If insufficient amounts are used it will fail to eliminate all the anodic sites. This will make the cathode / anode area ratio increase, leading to accelerated corrosion of the anodic site (Figure 6).

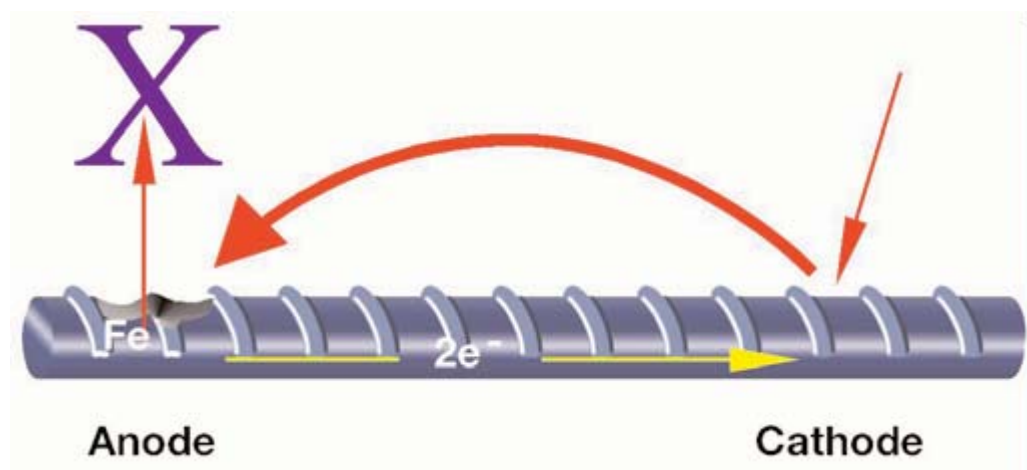

Figure 6: Anode suppressed

Typical generic types include those which are calcium nitrite based. A major drawback with the use of nitrites is the increasingly stringent environmental trends restricting their use.

5.2 Cathodic Inhibitors

These reduce the cathodic reaction by forming a barrier at the cathodic site preventing oxygen reaching the steel. The inhibitors can reduce corrosion rates at low dosage levels although they are generally less efficient than anodic type inhibitors (Figure 7).

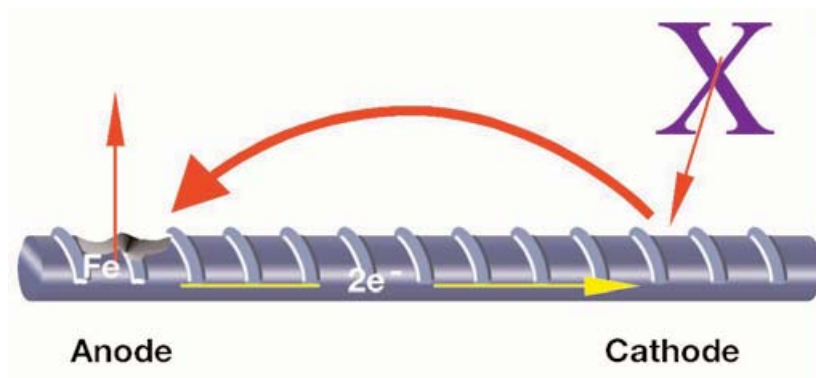

Figure 7: Cathode suppressed

5.3 Multifunctional (mixed) inhibitors

This class of inhibitor has a synergistic effect, combining the benefits of both the anodic and cathodic types at relatively low concentrations (Figure 8).

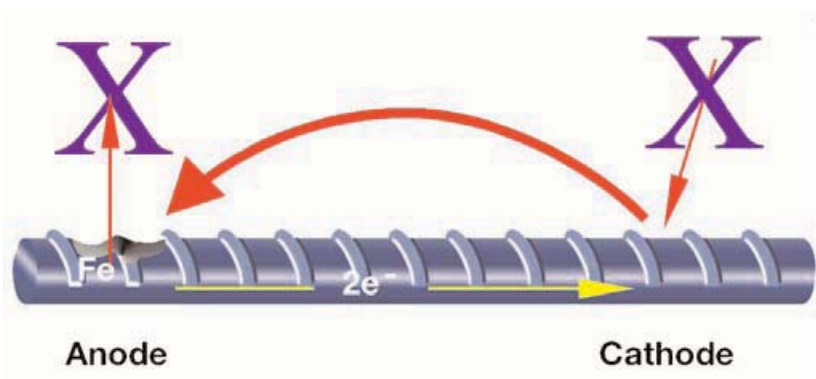

Figure 8: Cathode and Anode Suppressed

6. A new class of surface applied corrosion inhibitor - Sika® FerroGard®

Sika has been active since the 1970's in the development of amino alcohol based corrosion inhibitors and this resulted in the granting of general worldwide patents. This knowledge has led to further developments and the innovative **Sika® FerroGard®** inhibitor technology. The inhibitor developed by Sika, to protect steel reinforcement in concrete, is based on an organic and inorganic, film forming blended amino compound that can also exist in the vapour phase. When its applied to the concrete surface this allows the inhibitor to diffuse through the concrete as a vapour as well as a liquid.

Sika® FerroGard® is a Modified Amino Alcohol Corrosion Inhibitor (MAACI) that has been developed with the addition of further inorganic corrosion retarding radicals. The benefit of the **Sika® FerroGard®** technology, compared to the first generation basic amino alcohol inhibitors, is a greater affinity to the steel thus producing a thicker more durable protective layer. Additionally, the film is formed faster than before and the improved penetration speed and depths obtained.

7. How does Sika® FerroGard® work?

- Penetrates the concrete in liquid & vapour phase
- Displaces hydroxides on the steel surface in carbonated concrete
- Displaces chlorides on the steel surface
- Forms an adsorbed chemical layer 100-1000 angstrom thick on the surfaces of the steel reinforcement (Figure 9)
- Reduces iron dissolution at the anode
- Reduces oxygen access at the cathode

The result is that current densities are negligible and there is an increase in time to corrosion initiation and a reduction in the rate of corrosion. It is important at this stage to recognise that corrosion inhibitors are not miracle cures that stop corrosion. They “Buy” time in that to the owners, specifiers and contractors they offer a cost effective means of extending a structure’s life.

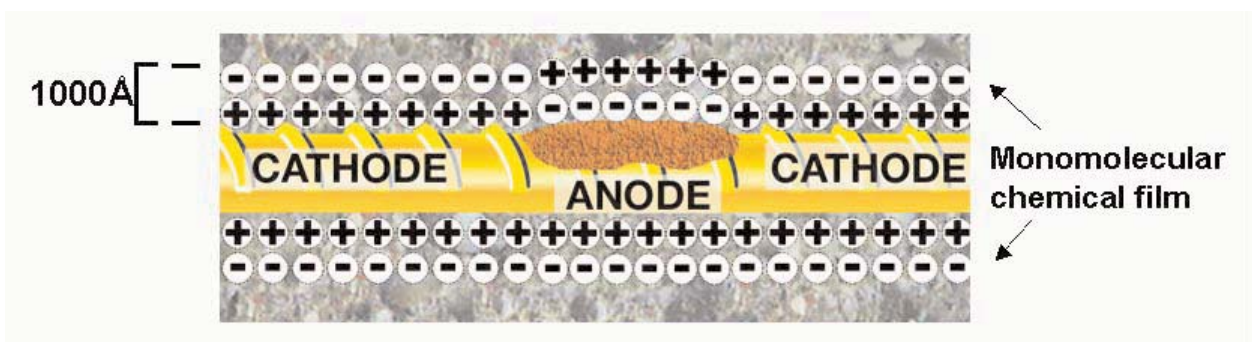

Figure 9: Adsorbed chemical layer on reinforcement

8. Where can Sika® FerroGard® inhibitor be used?

Sika® FerroGard® can be utilised in numerous concrete structures, these include:

- Buildings
- Bridges
- Tunnels
- Marine Structures
- Containment Structures.
- Towers
- Car Parks
- Pipelines

In effect **Sika® FerroGard®** can be used anywhere that new or particularly existing hardened reinforced concrete needs protection.

9. System application

Sika® FerroGard® should normally be applied as part of a complete corrosion management strategy incorporating cementitious repairs, levelling mortars and protective coatings. One of the benefits of the **Sika® FerroGard®** surface applied corrosion inhibitor is the reduced breakout of the carbonated or chloride contaminated structurally sound concrete. Only cracked, spalled or delaminating concrete requires removal. Once the local repairs have been carried out, the corrosion inhibitor can be applied. **Sika® FerroGard®** is applied similarly to a hydrophobic impregnation, but without the potentially hazardous solvent problems. Ideally the substrate should be clean and dry with surface contaminants removed. A consumption of 0.5kg/m² is recommended, applied by low pressure spray (Figure 10) subject to on site penetration testing. If it is required to apply a levelling mortar or surface coating after the inhibitor treatment, the inhibitor residue will need to be removed from the treated concrete.

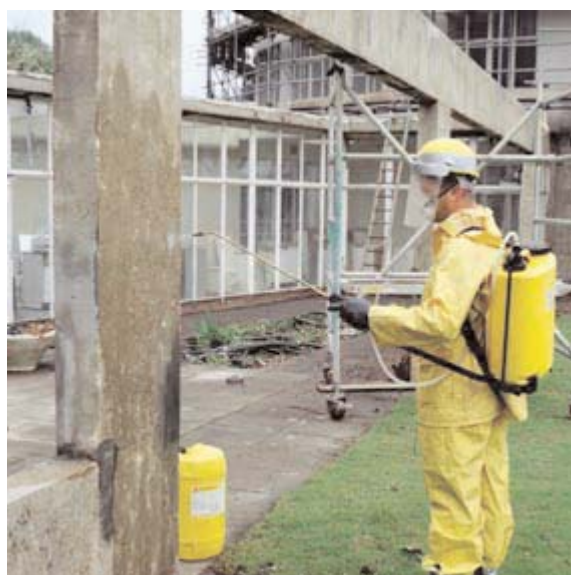

Figure 10: Application of **Sika® FerroGard®-903**

11. Corrosion monitoring

The foremost way to determine the effectiveness of a concrete repair strategy is by comprehensive corrosion rate monitoring on actual field installations. This assesses the adequacy of the repair strategy and predicts whether problems are likely in the future. By obtaining information on the condition of the structure reassurance can be given to prospective users, lessors and owners and allow early preventative maintenance or repairs to be undertaken. This approach may reduce the future cost of repair and minimise disturbance to users of the structure. Electrochemical corrosion monitoring involves more than simply carrying out half - cell potential measurements before and after the work. BRE digest 434 provides information on electrochemical monitoring techniques. Half - cell measurements alone can only give limited indications of the likelihood of corrosion, not necessarily the amount, and certainly not the rate. When this method is used on structures treated with **Sika® FerroGard®** the influence of **Sika® FerroGard®** on corrosion potential may result in no significant change (Figure 13). It is therefore preferable that the corrosion rate is monitored rather than the potential.

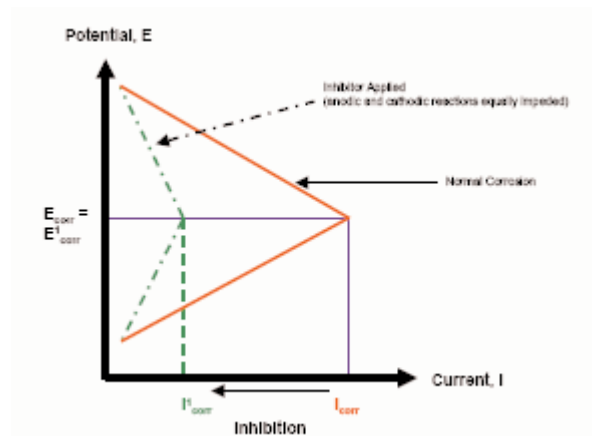
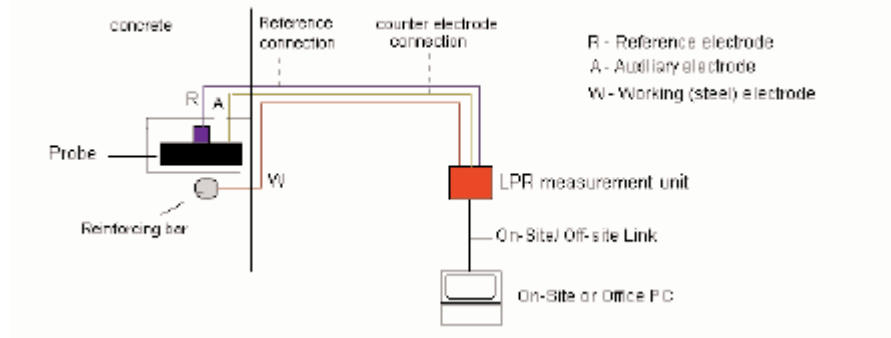

Figure 13

Using linear polarisation techniques actual corrosion rates can be measured for carbonated and chloride contaminated concrete. The results can be represented in $\mu\text{A}/\text{cm}^2$ as a current density or $\mu\text{m}/\text{yr}$ loss of steel.

The technique can be carried out using portable surface equipment, which requires site visits during the period of monitoring. Alternatively, embedded probes may be considered. Surface techniques are sensitive to external environmental conditions and assumptions of the confined area of the reinforcement being measured. This can lead to a high variability in accuracy of the data and questionable results, particularly at low corrosion rates experienced in carbonated concrete. Probes, embedded in concrete adjacent to the reinforcement, removes these variables and provides more accurate and consistent data. Measurements can be carried out manually, however, the preference is to use an automated system comprising of a linear polarisation resistance measurement device/unit connected to an on-site or remote PC (Figure 14).



Personalised Internet link also available

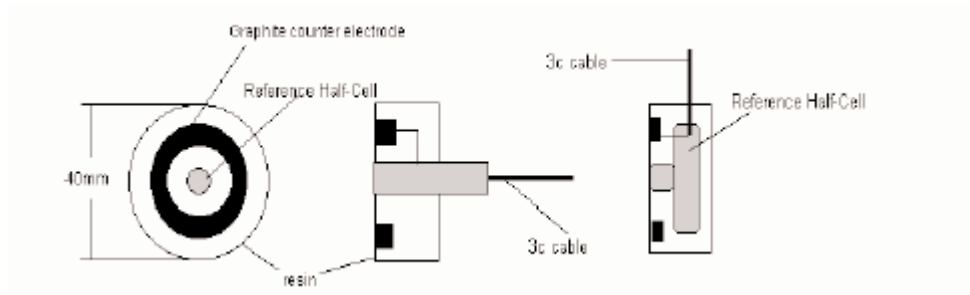

Figure 14: Corrosion rate monitoring – embedded probe system
[Courtesy of C-Probe Technologies]

For the monitoring system to provide useful accurate data, it is essential that the embedded probes, LPRM device/unit, on-site or remote PC and associated software are compatible. If the “bolt on” approach is taken, where the monitoring elements are obtained from different sources, the response and interpretation could be misleading and prone to providing inaccurate information. At present there is very limited expertise in this area and full evaluation of the system together with the corrosion experience of personnel should be investigated before embarking on this monitoring strategy. Although exact values can be indicative, they should not be classed as absolute. There are a number of assumptions and variables used in their calculations. A trend in the results is generally of more use with regard to the practical implications.

Corrosion rate information obtained from embedded probe monitoring can be observed in the case studies – Chapter 15. From these typical results to-date, it can be clearly shown that the effect of the repair strategy incorporating **Sika® FerroGard®** has demonstrated an improvement. The reduction of corrosion rates to levels which will increase the time to further corrosion and therefore extends the service life of the structure. This is illustrated in the service life corrosion model shown in Figure 15.

12. Performance testing

Extensive research programmes, both in the laboratory and on site, have yielded exceptionally interesting test results for those concerned with the protection of the nation's reinforced concrete structures. These tests have been carried out by some of the leading research institutions worldwide. For the purpose of this overview, the results and therefore performance properties of **Sika® FerroGard®** can be summarised as follows:

12.1 Penetration

Site trials and experimental test results have demonstrated that when applied to a concrete surface, **Sika® FerroGard®** can penetrate up to 30mm per day and up to a depth of 80mm at 28 days. Studies of the transport mechanism have yielded depth profiles showing a concentrated band of **Sika® FerroGard®-903** passing through the cover concrete to embedded steel. This penetration has occurred in a matter of days irrespective of the orientation of the application (horizontal, vertical, or overhead).

12.2 Corrosion Inhibition

Extensive laboratory and on-site monitoring have revealed that the film forming **Sika® FerroGard®** has successfully retarded the onset of corrosion.

12.3 Effects on Concrete

There are no reported adverse effects on the durability and integrity of reinforced concrete, nor does the application constitute any more of a health and safety risk than more conventional repair and protection techniques.

12.4 Protective Film Formation

Test results have shown that **Sika® FerroGard®**, when applied to simulated concrete pore water solutions containing chlorides, forms a continuous inhibitive film and actually displaces chloride ions from the surface of the steel, even when immersed in dilute saline solution.

Spectroscopy methods have identified the film to be composed of the parent amino alcohols and associated radicals, which cover the anodic and cathodic sites with a continuous film. The layer is typically 10-8 m thick and masks any trace of iron on the spectrograph which is indicative of a high integrity barrier layer. The passivation effect has been investigated by the BRE using Localised Electrochemical Impedance Spectroscopy. Further to this, whilst rinsing with water was shown to remove chloride ions from the steel surfaces, the rinsing of **Sika® FerroGard®** treated steel surfaces does not remove the protective film.

13. How long will Sika® FerroGard®-903 extend the life of a structure?

This will be dependant on the overall corrosion management strategy. Two comparisons are made below:

13.1 Concrete repairs plus Sika® FerroGard® – no coatings

- Anodic & cathodic sites protected.
- Electrolyte varies (wetting & drying cycles)
- Concrete pH varies (reduces with carbonation)
- Moisture & oxygen permeate
- **Sika® FerroGard®** is exposed to weathering

In this situation, the concrete is subjected to varying unstable conditions and therefore the properties of the concrete will determine the service life of the structure.

13.2 Concrete repairs plus Sika® FerroGard® - plus Sikagard® protective coatings

- All anodic and cathodic sites protected
- Electrolyte stabilised
- Concrete pH stabilised
- Moisture and oxygen levels reduced
- **Sika® FerroGard®-903** is not exposed to weathering
- Synergistic combination of inhibitor and coatings/hydrophic impregnations provides best overall protection and durability

In this situation, the properties of the coating system and the physical properties of the concrete determines the service life of the structure. The service life corrosion model shown in Figure 15 graphically shows the advantages of using **Sika® FerroGard®-903** and coatings.

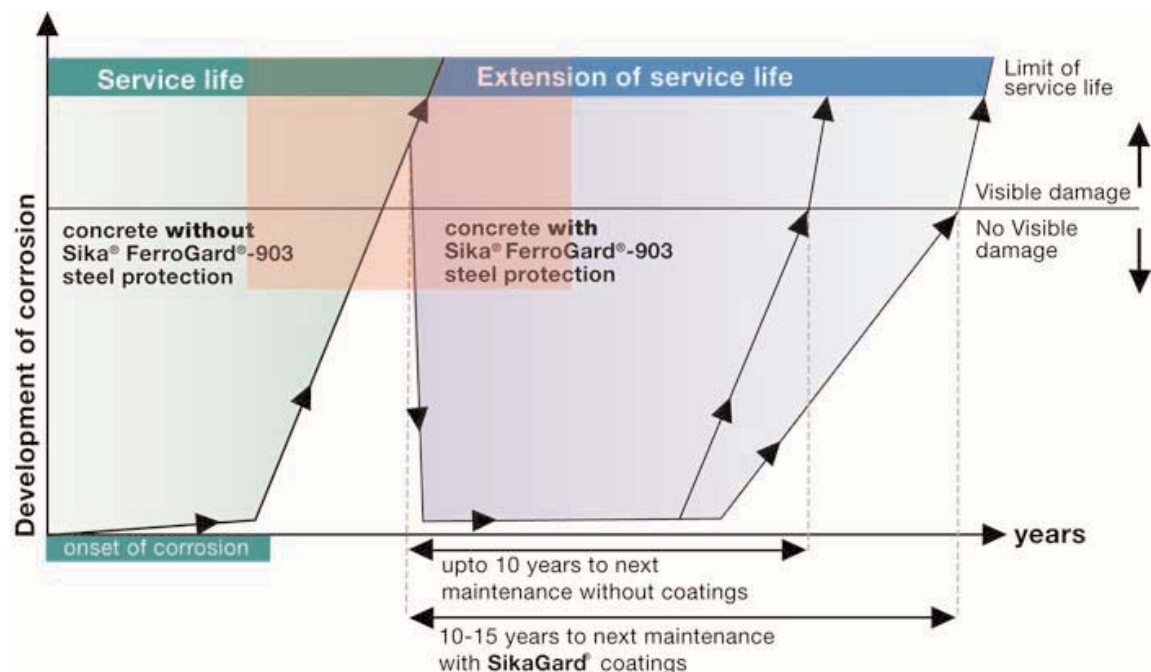

Figure 15: Service life corrosion model using **Sika® FerroGard®-903**

14. The benefits of Sika® FerroGard®

- Can be applied to concrete that contains up to 1-2% chloride ions by weight of cement
- Displaces hydroxides on the steel surface in carbonated concrete
- Dramatically reduces the incipient anode effect
- Reduces the amount of concrete breakout
- Reduces dust and noise levels
- Active in alkaline and carbonated concrete
- Can be applied to any surface orientation
- Can be applied to areas of limited access where other repair options could not be used
- Can be applied as a post treatment following localised repair techniques
- No adverse physical or chemical effects on the durability & integrity of the concrete
- Penetrates concrete in liquid and vapour form
- Only small quantities required
- Corrosion rate monitoring techniques can be used to monitor the effectiveness and durability
- On site testing available to check suitability of concrete and depth of penetration
- Non toxic
- No permanent electrical power required
- Can dramatically increase the service life of a structure
- EXTREMELY COST EFFECTIVE

15. Case studies

Case Study 1

Structure

Commercial Offices

Problem

- External precast cladding panels carbonated and low cover
- Internal stairwells contaminated with chlorides
- Cracked and spalled concrete
- Sealant failure between panels

Solutions

- **Sika® MonoTop®** repairs
- **Sika® FerroGard®-903**
- **Sikagard®** elastomeric coating
- **Sikaflex®** polyurethane joint sealant
- Corrosion rates reduced (response)

Inhibitor performance

- Measurements correlating: 4x floor levels; compass points; external and internal
- >95% lowering of corrosion rate in all areas
- Chloride contaminated areas reduced from >50 $\mu\text{m}/\text{yr}$ to 1-4 $\mu\text{m}/\text{yr}$
- Carbonated areas reduced from 20-100 $\mu\text{m}/\text{yr}$ to 1-2 $\mu\text{m}/\text{yr}$

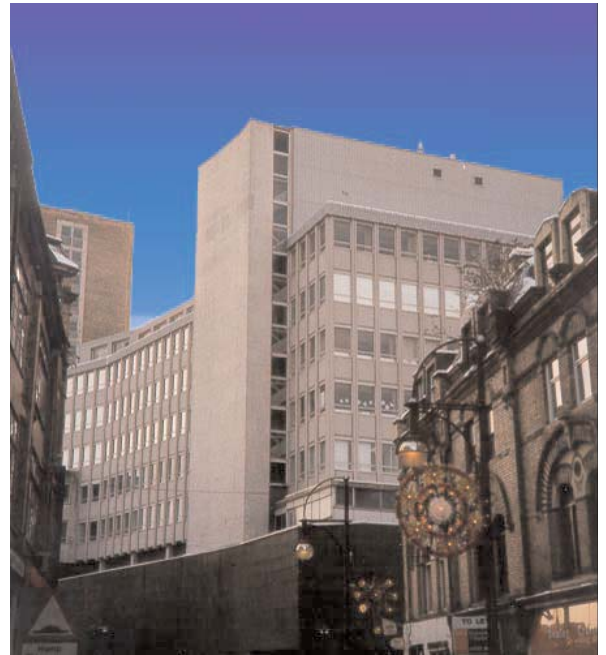

Corrosion rate $\mu\text{m}/\text{yr}$

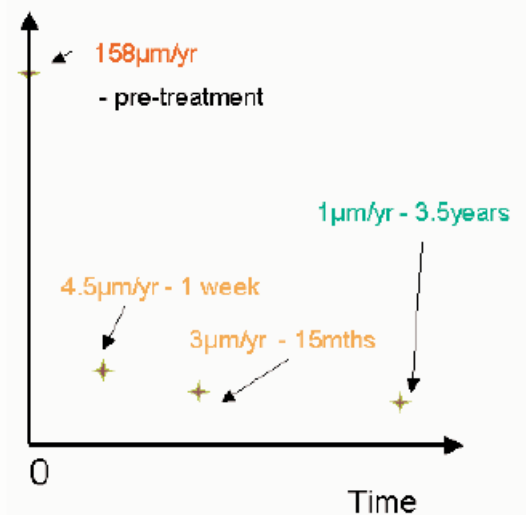

Case Study 2

Structure

Commercial Offices

Problem

- Low concrete cover and carbonation in 'napped' fluted precast concrete panels

Solutions

- **Sika® MonoTop®** repair
- **Sika® FerroGard®-903** (penetration tests)
- **Sikagard®** elastomeric coating
- **Sikaflex®** polyurethane joint sealant



Case Study 3

Structure

Bridge

Problem

- Prevention of carbonation and chloride damage to the high profile structure

Solutions

- Impregnation with **Sika® FerroGard®-903**



Case Study 4

Structure

Multi Storey Car Park



Problem

- Cracked and spalled concrete decks caused by chloride induced reinforcement corrosion



Solutions

- **Sika® MonoTop®** repair
- **Sika® FerroGard®-903**
- **Sikagard®** coating

Case Study 5

Structure

Road Bridge



Problem

- Chloride induced corrosion damage to half joints and deck soffit

Solutions

- Discrete anode impressed current cathodic protection system to half joints
- **Sika® FerroGard®-903** to deck soffits
- Corrosion rates reduced from 24.5 $\mu\text{m}/\text{year}$ - 6.4 $\mu\text{m}/\text{year}$
- Up to 10 years concrete durability



Case Study 6

Structure

Road Bridge

Problem

- Chloride induced corrosion damage to trestles, soffit and abutments

Solutions

- **Sika® FerroGard®-903** applied to structure

Inhibitor performance 9 months evaluation

North Abutment:

- reduction 54 $\mu\text{m}/\text{yr}$ to 0.6

North Trestle:

- reduction 26 $\mu\text{m}/\text{yr}$ to 0.3

South Trestle:

- reduction 3.6 $\mu\text{m}/\text{yr}$ to 0.2

South Abutment:

- reduction 45 $\mu\text{m}/\text{yr}$ to 0.8



Case Study 7

Structure

Reinforced concrete chimney

Problem

- Chloride induced corrosion on external and internal surface from flue gases

Solutions

- Sika® MonoTop® repair
- Sika® FerroGard®-903 (internal & external)
- Sikagard® coating

Inhibitor performance 1 month evaluation

Base of chimney:

- reduction 9.1 $\mu\text{m}/\text{yr}$ to 1.5

Middle of chimney:

- reduction 22.8 $\mu\text{m}/\text{yr}$ to 7.0

Top of chimney:

- reduction 39.51 $\mu\text{m}/\text{yr}$ to 4.33



Additional monitored information showing corrosion rate reduction

Project name	Location	Type of structure	Year of application	Number of monitoring points	Corrosion rate pre-treatment [μm per year loss of steel]	Corrosion rate after treatment [μm per year loss of steel]	Time since application of FerroGard 903
Houston Street Viaduct	Dallas	bridge cantilever	2002	6	50.5	1.0	3 months
City of Cleveland Police Garage	Cleveland	cast in place parking garage deck	2001	12	7.9	1.7	1 month
Maverick Resort	Daytona Beach	walkways balconies	2001	14	34.5 34.6	0.1 2.1	1 year 1 year

16. Conclusion

The use of corrosion inhibitors for the protection and remediation of reinforcement corrosion, is now accepted as a European principle for controlling corrosion.

The development of modified amino alcohol corrosion inhibitors at Sika are the result of extensive research and development to ensure our range of repair materials and concrete coatings are compatible and durability is maintained.

As part of a complete concrete repair strategy, the use of protective coatings provides an integral part of the system. They provide a stable concrete environment, by reducing the ingress of the deteriorating agents.

When assessing inhibitors, the specifier should be aware that inhibitor formulations vary greatly in corrosion protection performance. All inhibitors are not created equal, even within generic classifications.

The surface applied corrosion inhibitor should be selected on the basis of proven corrosion inhibiting properties, endorsed by third party corrosion rate monitoring in the laboratory and field application. The material must be capable of being identified within the concrete, using site testing techniques, to ascertain penetration into the concrete and presence at the recommended consumption rates. This also verifies whether the inhibitor should be considered as an option.

The coatings should be selected to achieve the desired performance requirements and satisfy the objectives of the repair strategy. Assessment of the suitability of the coating should be based on valid technical information supported by third party test certification and in-service track record. And finally, when used with corrosion inhibitors compatibility should be assured.

This systematic approach to corrosion management will ensure a cost effective and durable restoration for most reinforced concrete structures suffering from deterioration, and considerably extend their service life.

17. References

Mulheron, M, University of Surrey, "Corrosion Inhibitors for High Performance Reinforced Concrete Structures" – Paper presented at the SCI Conference, London – September 1999

Wood, Ian & Graham Jones, Field Applications Using Surface-Applied Corrosion Inhibitors – Paper presented at Inhibitor Conference, Aston University – January 2000

Mott MacDonald; Evaluation of FerroGard Corrosion Inhibitors ; 1996

Wolfseher & Partners AG, "Sika FerroGard 903 Corrosion Inhibitor - Material Technology Test - Baar, 6 March 1997, Report No. 96.144.11"

Morlidge, John, BRE – Localised Electrochemical Impedance Spectroscopy – Paper presented at the SCI Conference, London – September 1999