

- ① Skuaflo® Inspection Chamber UK - optional 100mm Extension Collar as necessary to suit ball depth
- ② Skuaflo® Protection Fence Ltd in strict accordance with Sika Limited Specification
- ③ Skuaflo® Rigid Drainage Layer 20 UK with integral fibrous layer
- ④ Skuaflo® Substrate Extensive UK normal 100mm deep extensive growing medium
- ⑤ Skuaflo® Substrate Blanket UK pre-grown sedge blanket
- ⑥ Skuaflo® River Stone 20/40 UK Normal 300mm wide gravel ballast border 20-40mm round washed river stone

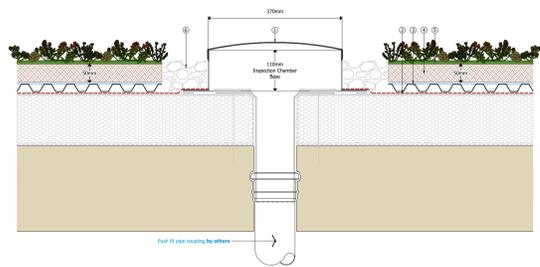

Typical Extensive Green Roof Drainage - Normal Clean Outlet

- ① Skuaflo® Protection Fence Ltd in strict accordance with Sika Limited Specification
- ② Skuaflo® Rigid Drainage Layer 20 UK with integral fibrous layer
- ③ Skuaflo® Substrate Extensive UK normal 100mm deep extensive growing medium
- ④ Skuaflo® Substrate Blanket UK pre-grown sedge blanket
- ⑤ Skuaflo® River Stone 20/40 UK Normal 300mm wide gravel ballast border 20-40mm round washed river stone

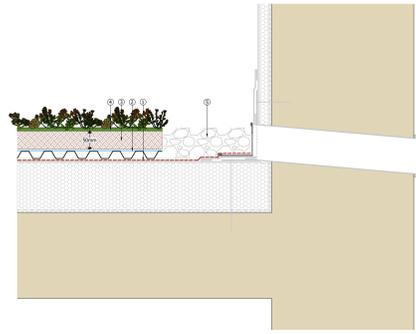

Typical Extensive Green Roof Drainage - Horizontal Clean Outlet

- ① Skuaflo® Aluminium Edge Trim UK installed using Skuaflo® Aluminium Edging Adhesive
- ② Skuaflo® Protection Fence Ltd in strict accordance with Sika Limited Specification
- ③ Skuaflo® Rigid Drainage Layer 20 UK with integral fibrous layer
- ④ Skuaflo® Substrate Extensive UK normal 100mm deep extensive growing medium
- ⑤ Skuaflo® Substrate Blanket UK pre-grown sedge blanket

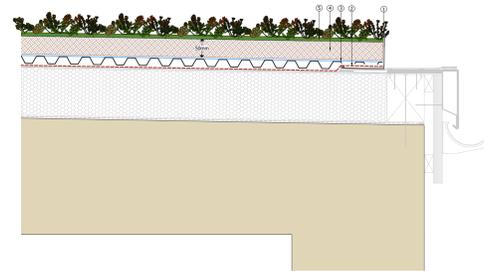

Typical Extensive Green Roof Drainage - 150mm Edge in Normal Clean Outlet

- ① Skuaflo® Protection Fence Ltd in strict accordance with Sika Limited Specification
- ② Skuaflo® Rigid Drainage Layer 20 UK with integral fibrous layer
- ③ Skuaflo® Substrate Extensive UK normal 100mm deep extensive growing medium
- ④ Skuaflo® Substrate Blanket UK pre-grown sedge blanket
- ⑤ Skuaflo® River Stone 20/40 UK Normal 300mm wide gravel ballast border 20-40mm round washed river stone

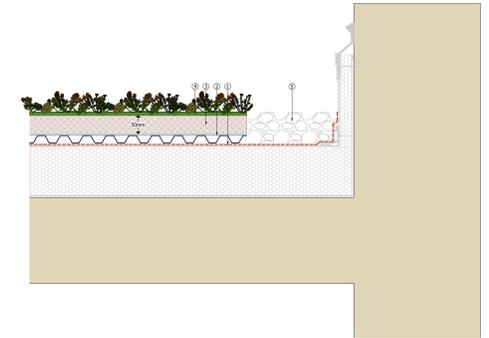

Typical Extensive Green Roof Drainage - Counterflashing

- ① Skuaflo® Protection Fence Ltd in strict accordance with Sika Limited Specification
- ② Skuaflo® Rigid Drainage Layer 20 UK with integral fibrous layer
- ③ Skuaflo® Substrate Extensive UK normal 100mm deep extensive growing medium
- ④ Skuaflo® Substrate Blanket UK pre-grown sedge blanket
- ⑤ Skuaflo® River Stone 20/40 UK Normal 300mm wide gravel ballast border 20-40mm round washed river stone

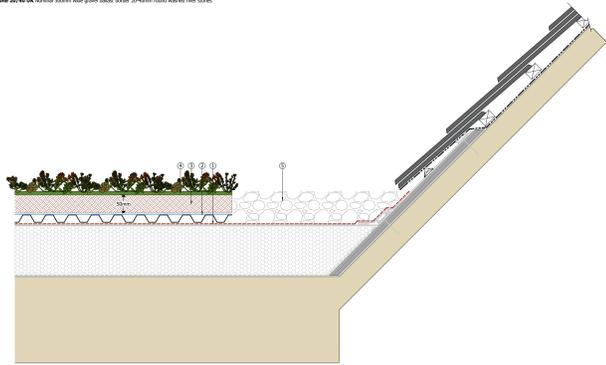

Typical Extensive Green Roof System - Pitched Roof Access

- ① Skuaflo® Protection Fence Ltd in strict accordance with Sika Limited Specification
- ② Skuaflo® Rigid Drainage Layer 20 UK with integral fibrous layer
- ③ Skuaflo® Substrate Extensive UK normal 100mm deep extensive growing medium
- ④ Skuaflo® Substrate Blanket UK pre-grown sedge blanket
- ⑤ Skuaflo® River Stone 20/40 UK Normal 300mm wide gravel ballast border 20-40mm round washed river stone

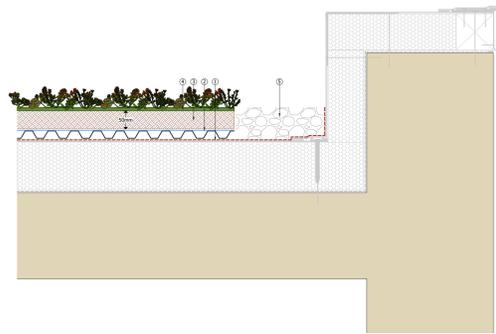

Typical Extensive Green Roof System - Pump

- ① Skuaflo® Protection Fence Ltd in strict accordance with Sika Limited Specification
- ② Skuaflo® Rigid Drainage Layer 20 UK with integral fibrous layer
- ③ Skuaflo® Substrate Extensive UK normal 100mm deep extensive growing medium
- ④ Skuaflo® Substrate Blanket UK pre-grown sedge blanket
- ⑤ Skuaflo® River Stone 20/40 UK Normal 300mm wide gravel ballast border 20-40mm round washed river stone

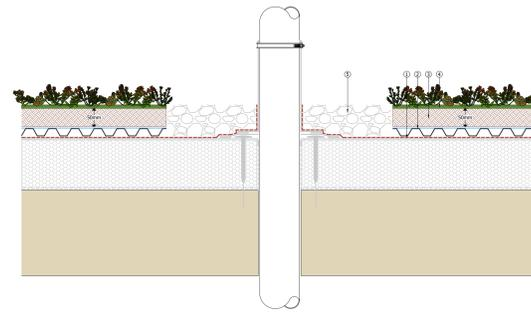

Typical Extensive Green Roof System - Pedestal - Pvc

- ① Skuaflo® Protection Fence Ltd in strict accordance with Sika Limited Specification
- ② Skuaflo® Rigid Drainage Layer 20 UK with integral fibrous layer
- ③ Skuaflo® Substrate Extensive UK normal 100mm deep extensive growing medium
- ④ Skuaflo® Substrate Blanket UK pre-grown sedge blanket
- ⑤ Skuaflo® River Stone 20/40 UK Normal 300mm wide gravel ballast border 20-40mm round washed river stone
- ⑥ Skuaflo® Light

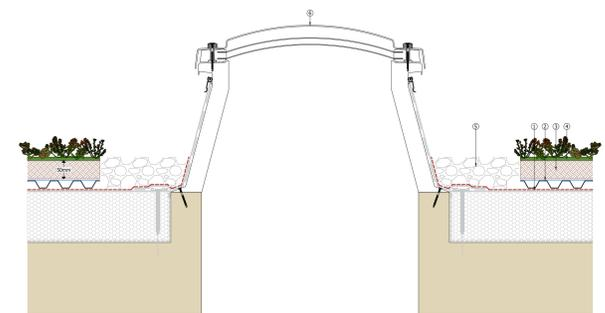

Typical Extensive Green Roof System - Skuaflo® Light

- Key
- ① Skuaflo® Protection Fence Ltd in strict accordance with Sika Limited Specification
- ② Skuaflo® Rigid Drainage Layer 40 UK
- ③ Skuaflo® Filter Fence Ltd in strict accordance with Sika Limited Specification
- ④ Skuaflo® Substrate Intensive UK
- ⑤ Skuaflo® River Stone 20/40 UK Normal 300mm wide gravel ballast border 20-40mm round washed river stone
- ⑥ Skuaflo® Inspection Chamber UK - utilising the 100mm Extension Collar

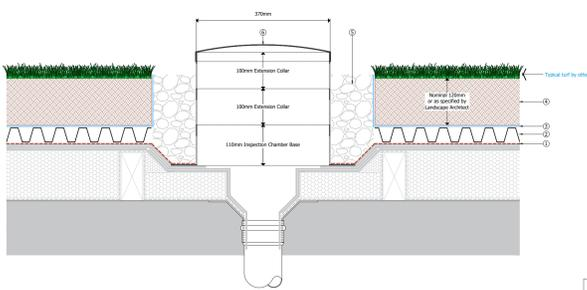

Typical Intensive Green Roof Drainage - Internal Vertical Outlet

- Key
- ① Skuaflo® Aluminium Edge Trim UK used directly in front of the chute outlet
- ② Skuaflo® Protection Fence Ltd in strict accordance with Sika Limited Specification
- ③ Skuaflo® Rigid Drainage Layer 40 UK
- ④ Skuaflo® Filter Fence Ltd in strict accordance with Sika Limited Specification
- ⑤ Skuaflo® Substrate Intensive UK
- ⑥ Skuaflo® River Stone 20/40 UK Normal 300mm wide gravel ballast border 20-40mm round washed river stone

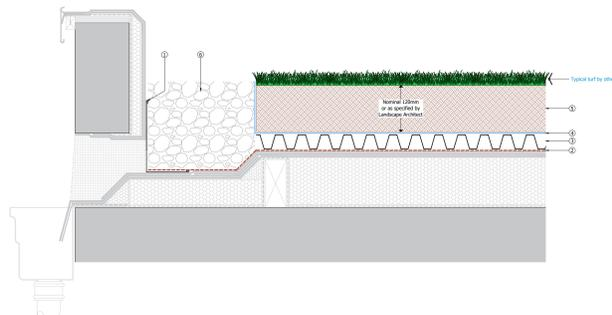

Typical Intensive Green Roof Drainage - Horizontal Clean Outlet

- Key
- ① Skuaflo® Protection Fence Ltd in strict accordance with Sika Limited Specification
- ② Skuaflo® Rigid Drainage Layer 40 UK
- ③ Skuaflo® Filter Fence Ltd in strict accordance with Sika Limited Specification
- ④ Skuaflo® Substrate Intensive UK
- ⑤ Skuaflo® River Stone 20/40 UK Normal 300mm wide gravel ballast border 20-40mm round washed river stone

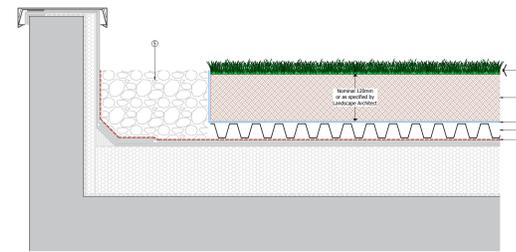

Typical Intensive Green Roof Drainage - Counterflashing

- Key
- ① Skuaflo® Protection Fence Ltd in strict accordance with Sika Limited Specification
- ② Skuaflo® Rigid Drainage Layer 40 UK
- ③ Skuaflo® Filter Fence Ltd in strict accordance with Sika Limited Specification
- ④ Skuaflo® Substrate Intensive UK
- ⑤ Skuaflo® River Stone 20/40 UK Normal 300mm wide gravel ballast border 20-40mm round washed river stone
- ⑥ Skuaflo® Light

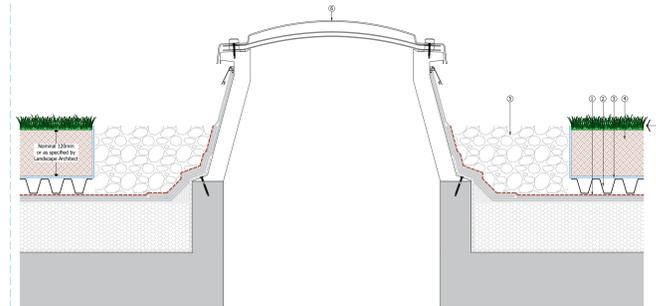

Typical Intensive Green Roof System - Skuaflo® Light

- Key
- ① Skuaflo® Aluminium Edge Trim UK installed in strict accordance with Sika Limited Specification
- ② Skuaflo® Protection Fence Ltd in strict accordance with Sika Limited Specification
- ③ Skuaflo® Rigid Drainage Layer 20 UK with integral fibrous layer
- ④ Skuaflo® Substrate Bio-Diverse UK normal 100mm deep bio-diverse growing medium
- ⑤ Skuaflo® Willowover Blanket UK or Skuaflo® Willowover Plugs UK or as specified by Landscape Architect

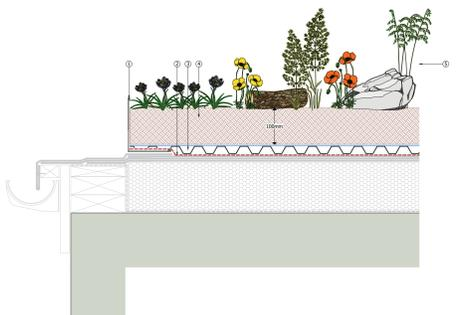

Typical Bio-Diverse Green Roof Drainage - 150mm Edge in Normal Clean Outlet

- Key
- ① Skuaflo® Protection Fence Ltd in strict accordance with Sika Limited Specification
- ② Skuaflo® Rigid Drainage Layer 20 UK with integral fibrous layer
- ③ Skuaflo® Substrate Bio-Diverse UK normal 100mm deep bio-diverse growing medium
- ④ Skuaflo® Willowover Blanket UK or Skuaflo® Willowover Plugs UK or as specified by Landscape Architect
- ⑤ Skuaflo® River Stone 20/40 UK Normal 300mm wide gravel ballast border 20-40mm round washed river stone

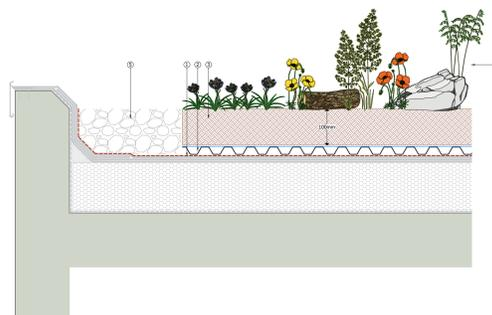

Typical Bio-Diverse Green Roof Drainage - Horizontal Clean Outlet

- Key
- ① Skuaflo® Protection Fence Ltd in strict accordance with Sika Limited Specification
- ② Skuaflo® Rigid Drainage Layer 20 UK with integral fibrous layer
- ③ Skuaflo® Substrate Bio-Diverse UK normal 100mm deep bio-diverse growing medium
- ④ Skuaflo® Willowover Blanket UK or Skuaflo® Willowover Plugs UK or as specified by Landscape Architect
- ⑤ Skuaflo® River Stone 20/40 UK Normal 300mm wide gravel ballast border 20-40mm round washed river stone

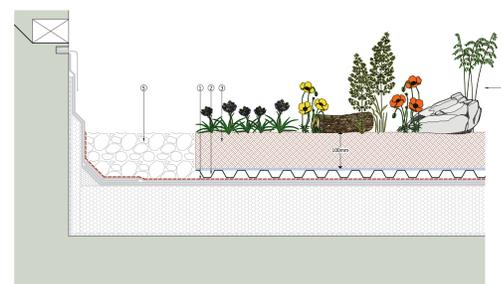

Typical Bio-Diverse Green Roof Drainage - Pedestal - Counterflashing

- Key
- ① Skuaflo® Protection Fence Ltd in strict accordance with Sika Limited Specification
- ② Skuaflo® Rigid Drainage Layer 20 UK with integral fibrous layer
- ③ Skuaflo® Substrate Bio-Diverse UK normal 100mm deep bio-diverse growing medium
- ④ Skuaflo® Willowover Blanket UK or Skuaflo® Willowover Plugs UK or as specified by Landscape Architect
- ⑤ Skuaflo® River Stone 20/40 UK Normal 300mm wide gravel ballast border 20-40mm round washed river stone

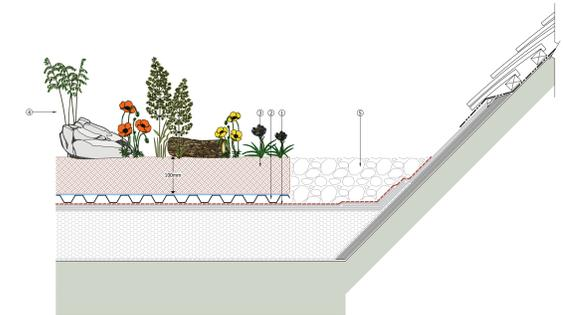

Typical Bio-Diverse Green Roof Drainage - Pitched Roof Access

| INFORMATION   |                         |
|---|-------------------------|
| Drawing Title:  | Sika Green Roof Systems |
| Project Ref:  |                         |
| Drawn By:   |                         |
| Checked By:   |                         |
| Scale:  | NTS @ A0                |
| Drawn:  | GRW                     |
| Check/Trace Services:   | 09th April '24          |
| <small>           This drawing is the property of Sika Limited and is not to be reproduced, stored in a retrieval system, or transmitted in any form or by any means, electronic, mechanical, photocopying, recording, or by any information storage and retrieval system, without the prior written permission of Sika Limited.         </small> |                         |
|   |                         |