

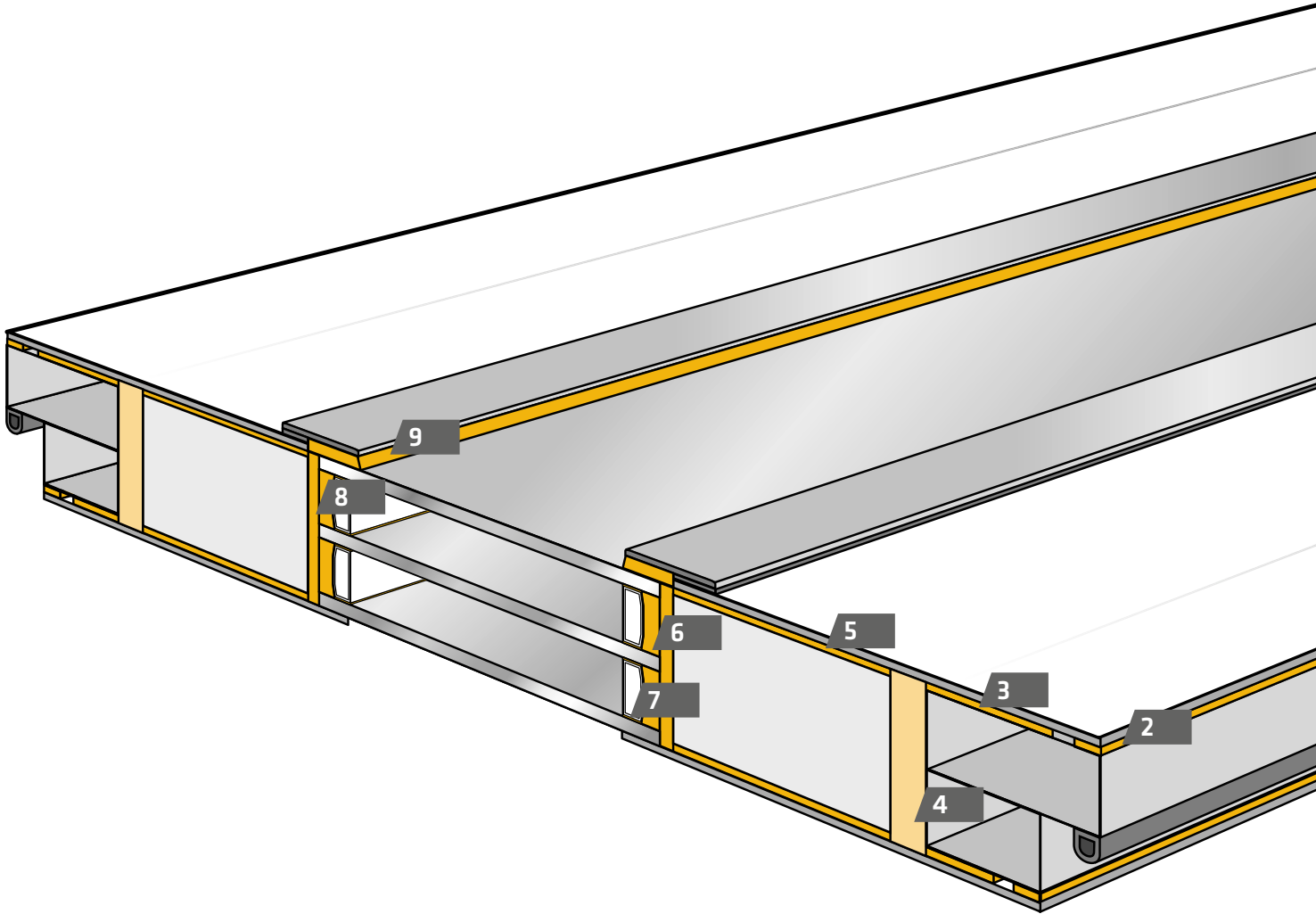

FRONT DOORS PROCESS MATERIALS

SEALING AND BONDING PRODUCTS FOR FRONT DOOR PRODUCTION



1

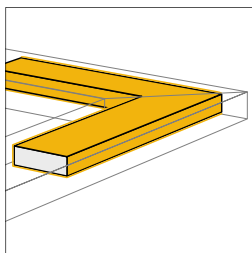

Corner bracket bonding

2

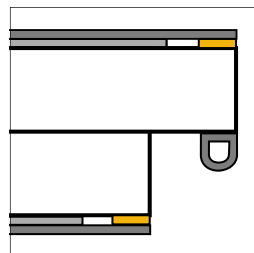

Mounting aid

3

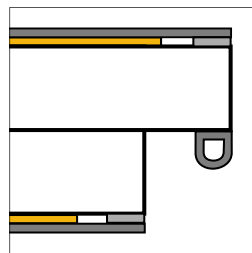

Frame and cover bonding

4

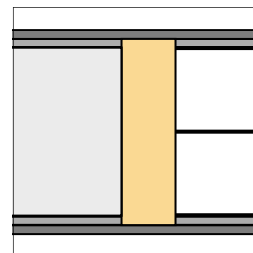

Thermal insulation

5

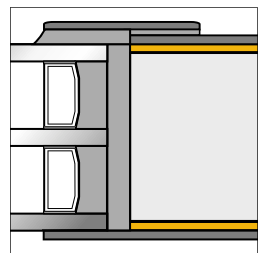

Sandwich Panel bonding

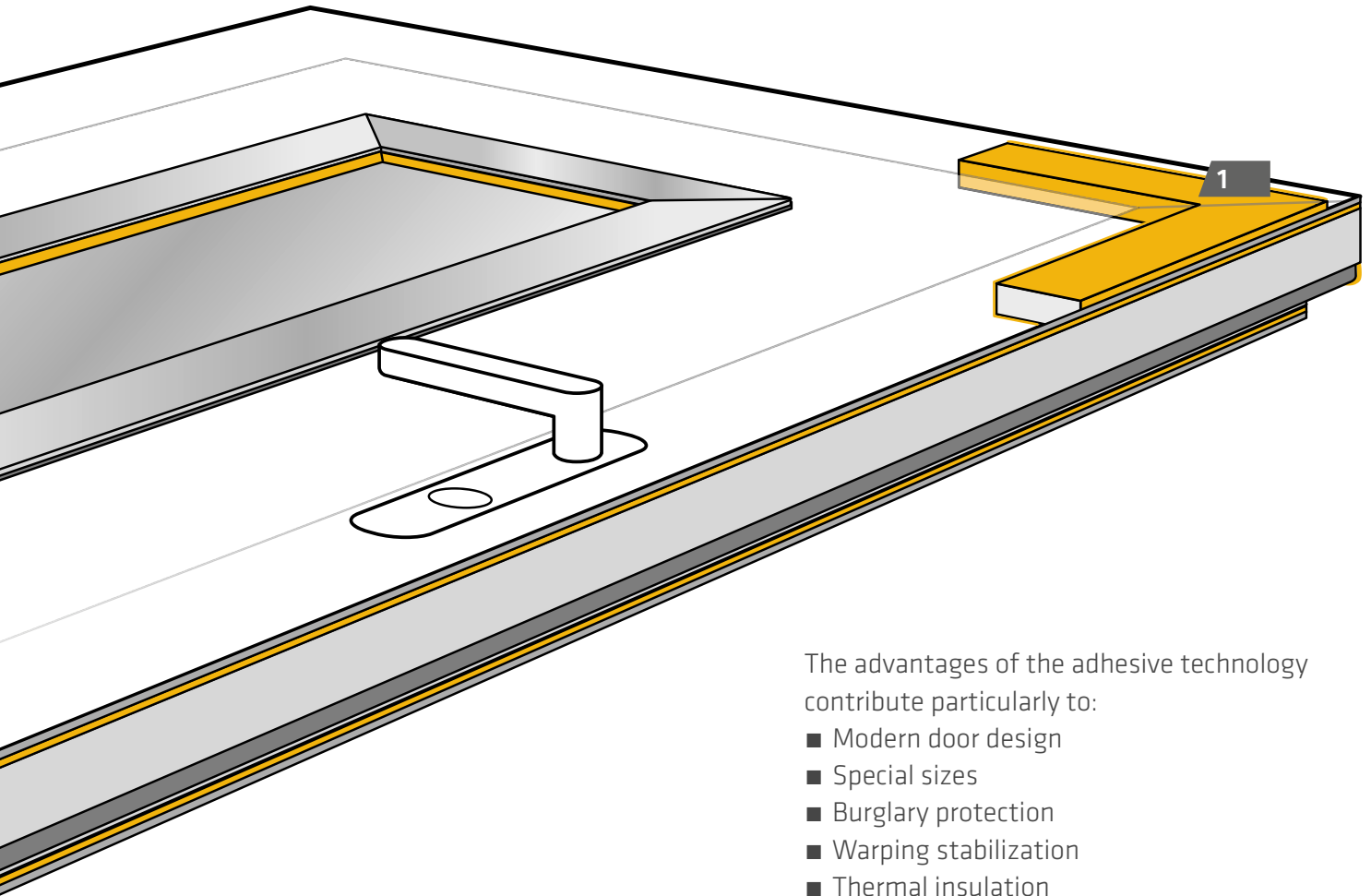

Sika technologies for the production of entrance doors out of wood, PVC and aluminium are suitable for single and serial production of door panels, frames as well as side panel glazing made of various materials.

The advantages of the adhesive technology contribute particularly to:

- Modern door design
- Special sizes
- Burglary protection
- Warping stabilization
- Thermal insulation

Sika adhesives and sealants are:

- Weatherproof
- Temperature resistant
- Process optimised
- Tested by certification institutes

6

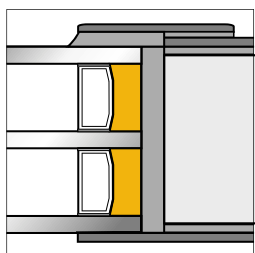

IG secondary sealing

7

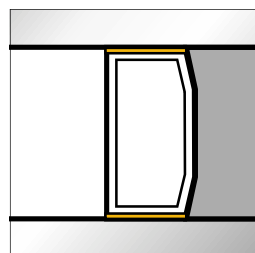

IG primary sealing

8

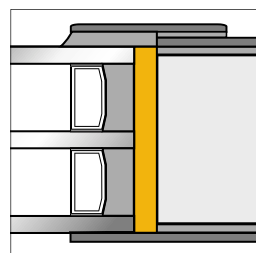

Burglary protection

9

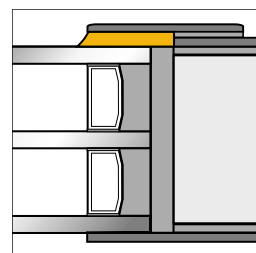

Glazing

SEALING AND BONDING PRODUCTS

	Product Name Technology	Application	Characteristics	Roll 50m	Can Set A+B	Cart- ridge	Uni-pack	Cylinder drum	Pail 20 l	Drum 200 l
1	SikaForce®-7900 2C PU	Corner bonding	High mechanical strength			●			●	●
2	Sika®Glazing Tape Prefix	Mounting aid	Acrylic adhesive UV-stable	●						
3	Sikaflex®-221 1C PU	Frame and cover bonding	Highly elastic Good adhesion			●	●		●	●
3	Sikaflex®-553 2C PU	Frame and cover bonding	Highly elastic Good adhesion			●	●		●	●
3	Sikasil® SG-500 2C silicone	Frame and cover bonding	UV-stable ETA certified							● ¹⁾
3	Sikasil® SG-20 1C silicone	Frame and cover bonding	UV-stable ETA certified			●	●		●	●
4	SikaBond® FoamFix 1C PU	Thermal insulation	Good thermal insulation No postexpansion		●					
5	SikaForce®-7710 L35 2C PU	Sandwich Panel bonding	Wide application range		●				●	●
6	SikaGlaze® IG-25 HM plus 2C silicone	IG secondary sealing	High UV-stability Low argon permeation							● ¹⁾
7	SikaGlaze® IG-5 PIB Butyl	IG primary sealing	Available in black and grey					●		
8	Sikasil® WT-480 2C silicone	Burglary protection	Compatible with IG edge seal			●			● ²⁾	● ¹⁾
9	Sikasil® WS-605 S 1C silicone	Glazing sealant	Weather resistant			●	●		●	●

¹⁾ A-component in 200 l drum, B-component in 20 l pail

²⁾ A- and B-component in 20 l pail

PRETREATMENTS

Product	Application	Unit
Sika® Activator-205	Surface pretreatment	Can 250 ml, 1 l
Sika® Primer-209 D	Surface pretreatment	Can 250 ml, 1 l
Sika® PowerClean Aid	Primer application cleaning	Box 24 pcs



CLEANER

Product	Type	Unit
Sika® Cleaner P	Surface cleaner	Can 250 ml, 5 l
Sika® Remover-208	Cleaner	Can 30 ml, 250 ml, 1 l
Sika® Handclean	Cleaning towels	Bucket 70 towels
Sika® CleanGlass	Glass cleaner	Bottle 500 ml



PRODUCT PROPOSAL

1 SikaForce®-7900



Product advantages

- High mechanical strength
- Wide adhesion range
- Mixing ratio 1:1 by volume
- Short mixer for waste reduction
- ift-approved

2 Sika® Glazing Tape Prefix



Product advantages

- Instant adhesion on many substrates
- UV-stable
- Protection liner easily to remove

3 Sikaflex®-221/-553



Product advantages

- High elasticity
- High tear strength
- Easy to apply
- Sikaflex®-553 moisture-independent curing

3 Sikasil® SG-500/SG-20



Product advantages

- Highly UV-stable
- High elasticity
- Easy to apply
- ETA-approval for structural glazing

4 SikaBond® FoamFix



Product advantages

- Low post-expansion
- Fast and easy application
- Adhesion on all common insulation materials
- Highly sound dampening

5 SikaForce®-7710 L35



Product advantages

- Wide adhesion range
- Moisture-independent curing
- Long open time
- Short press time
- Solvent free

8 Sikasil® WT-480



Product advantages

- Mainly compatible with IG edge sealant
- Approved by system providers for burglary protection
- Outstanding adhesion range
- Highly UV-stable

9 Sikasil® WS-605 S



Product advantages

- Outstanding UV- and weathering resistance
- Good adhesion on glass, metal, plastics and wood
- Non-staining to adjacent materials

GLOBAL BUT LOCAL PARTNERSHIP



FOR MORE INFORMATION:



www.sika.com/ses

WHO WE ARE

Sika is a specialty chemicals company with a leading position in the development and production of systems and products for bonding, sealing, damping, reinforcing and protecting in the building sector and the motor vehicle industry. Sika has subsidiaries in 90 countries around the world and manufactures in over 160 factories. Its more than 17,000 employees generated annual sales of CHF 5,6 billion in 2014.

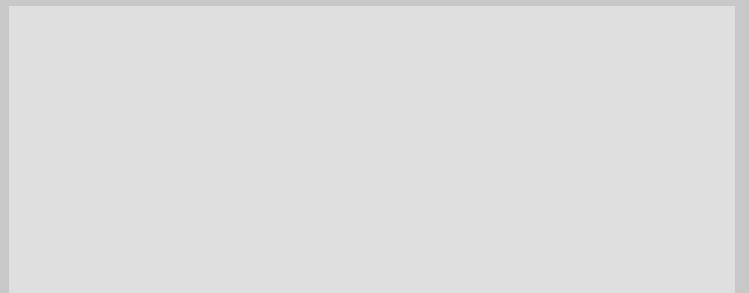

Our most current General Sales Conditions shall apply.
Please consult the Data Sheet prior to any use and processing.



SIKA SERVICES AG

Tueffenwies 16
CH-8048 Zurich
Tel. +41 (0) 58 436 40 40
Fax +41 (0) 58 436 55 30
www.sika.com

BUILDING TRUST

